

SenseVue™ Customizable Surround Sensor System w/ LED Display

RVS-SenseVue



(Up to 16 Sensors)



Instruction Manual

TABLE OF CONTENTS

| | |
|--------------------------------------|-----|
| Table of contents | 2 |
| Introduction | 3 |
| Safety Information | 4-5 |
| Required Tools | 6 |
| System Content | 6 |
| Wire Diagram | 7 |
| Display Function | 8 |
| Sensor Location Requirements | 9 |
| Sensor Location Examples | 10 |
| Sensor and Sleeve Mounting | 11 |
| Door Installation Instructions | 12 |
| Harness Routing | 13 |
| ECU Installation | 14 |
| GPS and Display Locations | 15 |
| Functionality Check | 16 |
| Technical Specification | 17 |
| Warranty | 18 |
| Disclaimer | 19 |

INTRODUCTION

With this product, you are taking an active part in reducing dangerous road traffic events while keeping yourself, passengers, and pedestrians safe. This manual will take you step by step through the installation process and usage of SenseVue™.

Please read all of the installation instructions carefully before installing the product. Improper installation will void manufacturer's warranty.

SAFETY INFORMATION

PLEASE READ THE ENTIRE MANUAL AND FOLLOW THE INSTRUCTIONS AND WARNINGS CAREFULLY. FAILURE TO DO SO CAN CAUSE SERIOUS DAMAGE AND/OR INJURY, INCLUDING LOSS OF LIFE. BE SURE TO OBEY ALL APPLICABLE LOCAL TRAFFIC AND MOTOR VEHICLE REGULATIONS AS IT PERTAINS TO THIS PRODUCT. IMPROPER INSTALLATION WILL VOID MANUFACTURER'S WARRANTY.

USAGE: The Sensor System is designed to help the driver improve their attention on the road and avoid accidents stemming from distractions. However, you the driver, must use it properly. Use of this system is not a substitute for safe, proper or legal driving.

INSTALLATION

Electric shock or product malfunction may occur if this product is installed incorrectly.

- Use this product within the voltage range specified; failure to do so can cause electronic shock or product malfunction
- Take special care when cleaning the monitor
- Make sure to firmly affix the product before use
- If smoke or a burning smell is detected, disconnect the system immediately
- Where the power cable may touch a metal case, cover the cable with friction tape; a short circuit or disconnected wire may cause a fire
- While installing the RVS System, be careful with the wire positioning in order to avoid wire damage
- Do not watch movies or operate the monitor while driving, as it may cause an accident

- Do not install the monitor where it may obstruct the driver's view or obstruct an airbag device
- Dropping the unit may cause possible mechanical failure
- When in reverse, monitor buttons are not functional

BEFORE USING SenseVue™, CAREFULLY READ THE FOLLOWING SAFETY INSTRUCTIONS AND WARNINGS THIS GUIDE CONTAINS











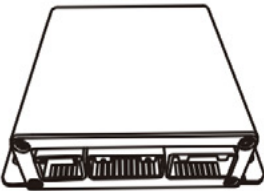

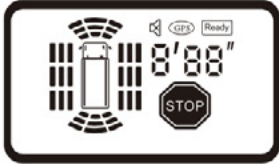





Reading the instruction of this manual before using SenseVue™ is mandatory:

1. The use of the system does not constitute a permit for the driver to drive the vehicle illegally or an authorization to breach road traffic laws. Any violation of traffic laws is the sole responsibility of the driver. RVS will not compensate the drivers for any damage caused to the driver and/or passengers of the vehicle and/or vehicle and shall have no responsibility arising from the behaviors mentioned above.
2. The SenseVue™ system only alerts (in accordance with system restrictions) the drivers against hazards depending on the features installed in the system. The final decision on how to operate/control the vehicle will be made by the drivers and their responsibility.

REQUIRED TOOLS

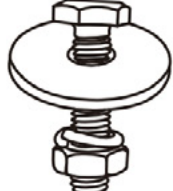
1. 25mm hole saw
2. Trim Removal tools
3. Wire cutters
4. Power Drill (driver bits and sockets needed)
5. Electrical Tape
6. Solder
7. Painters tape and a marker

SYSTEM CONTENT

| | | | |
|--|--|---|---|
| <p>ECU×1</p>  | <p>Sensor×14</p>  | <p>Led Display×1</p>  | <p>GPS×1</p>  |
| <p>Power Harness×1</p>  | <p>4 Way Sensor Cable</p>  | <p>Led Display Cable to ECU</p>  | <p>Bracket for display</p>  |
| <p>Sensor Cable for Left ×1</p>  | <p>Sensor Cable for Right×1</p>  | <p>Sensor Cable for Front×1</p>  | <p>Sensor Cable for Rear×1</p>  |
| <p>2m extension cable for left sensor×1</p>  | <p>2.7m extension cable for display</p>  | <p>4m extension cable for Rear sensor×1</p>  | <p>Screws×4</p>  |
| <p>Hole Saw×1</p>  | <p>Cable Tie ×30</p>  | <p>3M tape ×1</p>  | <p>Installation Manual ×1</p>  |

WIRE DIAGRAM

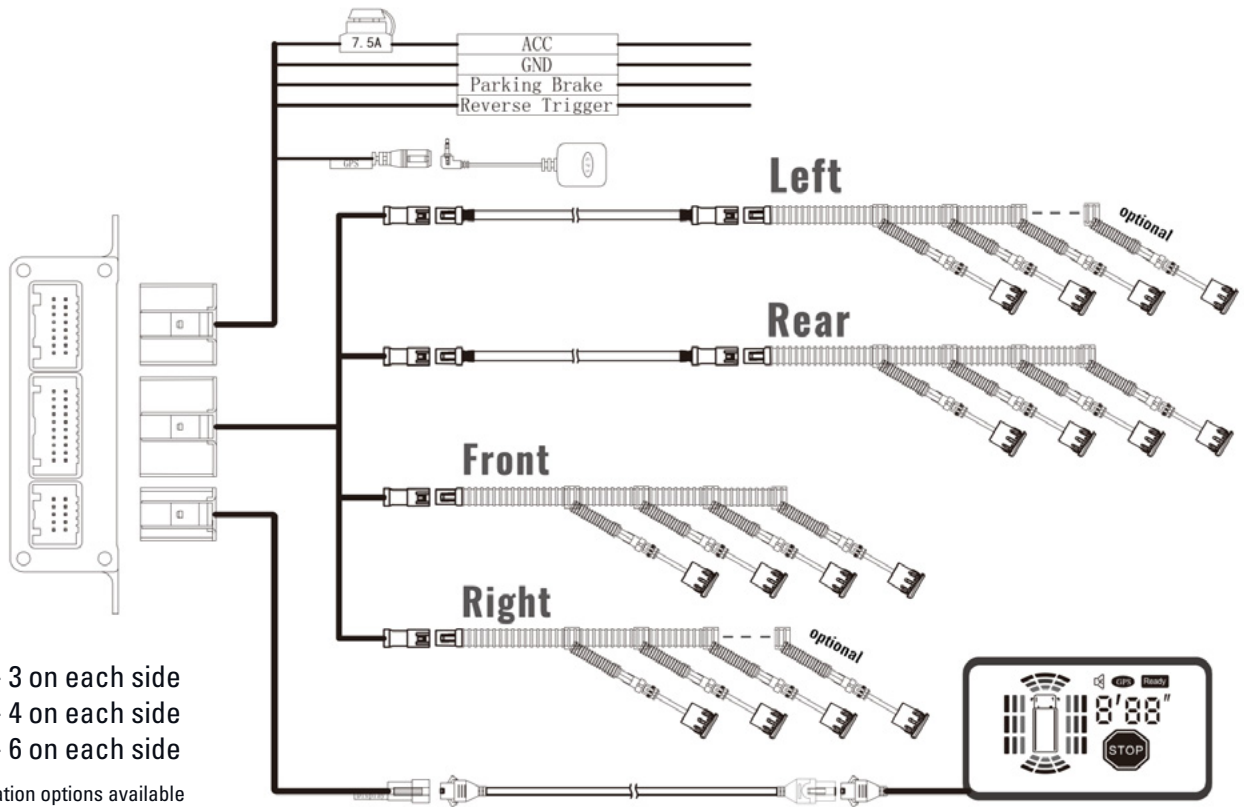

12 sensors - 3 on each side
 14 sensors - 4 on each side
 16 sensors - 6 on each side
 *other customization options available

SENSOR PLACEMENT AND DETECTION RANGE

14 Sensors Placement

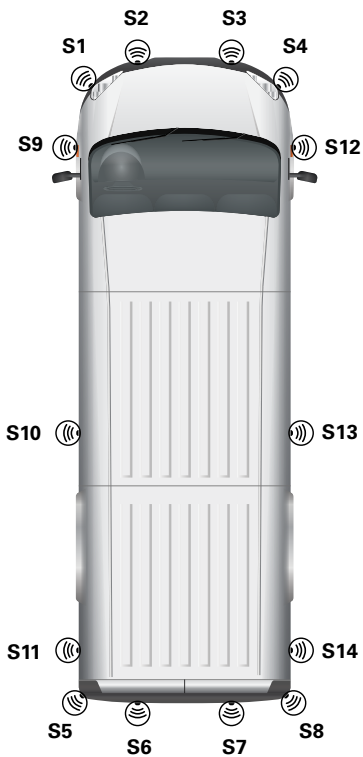

16 Sensors Placement

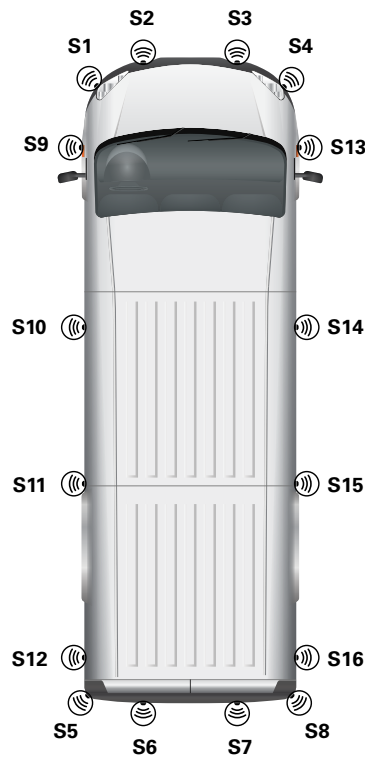

Detection Range

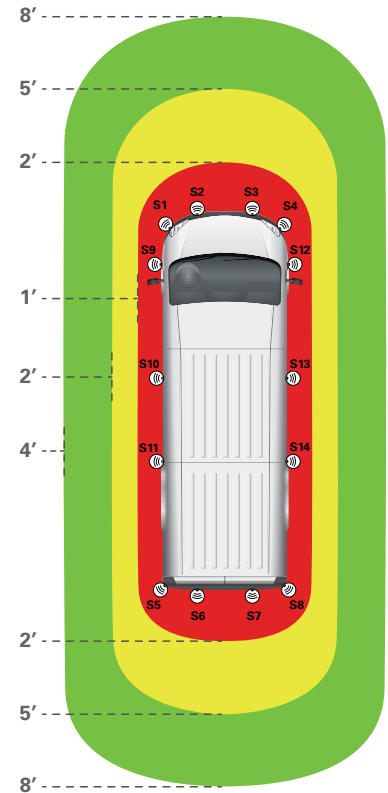

DISPLAY FUNCTION

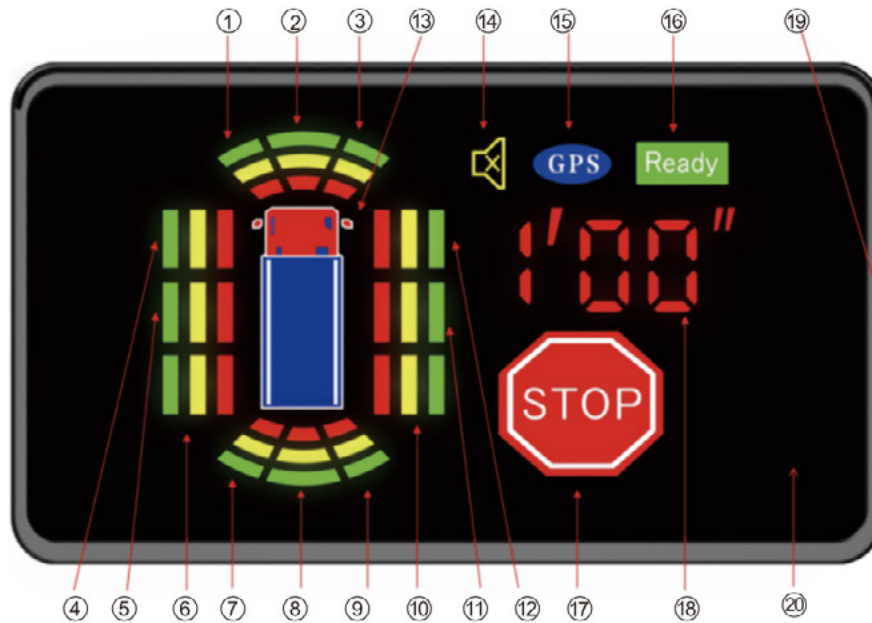

| NO | Function Description | NO | Function Description |
|----|-----------------------------|----|---|
| ① | Front Sensor (S1) | ⑪ | Right Sensor(S13) |
| ② | Front Middle Sensor (S2,S3) | ⑫ | Right Sensor(S12) |
| ③ | Front Sensor (S4) | ⑬ | Vehicle Model, it appears when sensor are active, and disappear when sensors are shut down |
| ④ | Left Sensor (S9) | ⑭ | Sound Status Mute - Highlight With sound - off |
| ⑤ | Left Sensor (S10) | ⑮ | GPS connection status display When not connected - not lit When connected - flashing When positioning is valid - highlight |
| ⑥ | Left sensor(S11) | ⑯ | Ready means system working properly |
| ⑦ | Rear Sensor(S5) | ⑰ | When the distance is less than 1ft shows"STOP" |
| ⑧ | Rear Middle Sensor(S6,S7) | ⑱ | Nearest distance between the sensor and the obstacle |
| ⑨ | Rear Sensor(S8) | ⑲ | Buzzer Adjustment: High,Middle Low volume can be option |
| ⑩ | Right Sensor(S14) | ⑳ | Light Sensor, Automatically adjust display brightness according to ambient light |

SENSOR LOCATION REQUIREMENTS

Sensor installation height and the space between each sensor is important and will vary from vehicle type to vehicle type. Follow the basic requirements below and refer to the vehicle type suggestions that follow.

For all sensor mounting locations, the mounting surface should be perpendicular to the ground, and should not point the sensor in a downward direction. Each location should also be parallel to the side of the vehicle and allow the sensor to point directly out from the side it is installed on. Make sure there is over an inch of open space behind the surface for the sensor to fit.

Installation Height: 20"-34" will provide the best results

Installing above or below this range can result in false alerts or missed obstacles. For side sensors, it may be difficult to find good locations that are all the exact same height from the ground. Small changes in height are acceptable, but should not vary more than 1ft.

Front/Rear Sensor Spacing: 1ft-2ft will provide best results

Greater spacing can be used if needed, but should be avoided if possible.

Left/Right Sensor Spacing: Should not exceed 4.5ft (14 Sensor System Variant)

Based on acceptable location of the rear most sensors, S11/S14, and the forward most sensors, S9/S12, try to equally space S10/13 between them. The total distance between outer sensors should not exceed 9 feet and the middle sensor should be as centered as possible. (See harness routing diagram for reference).

After measuring and checking the front and back of each sensor location, mark the sensor locations using tape and a marker.

SENSOR LOCATION EXAMPLES

Here are some basic vehicle types that the system can be installed on. Each blue “X” represents a sensor. Use these examples as a baseline when evaluating areas on a vehicle for side sensor placement. These general areas should provide the best side coverage and require the fewest door installations.

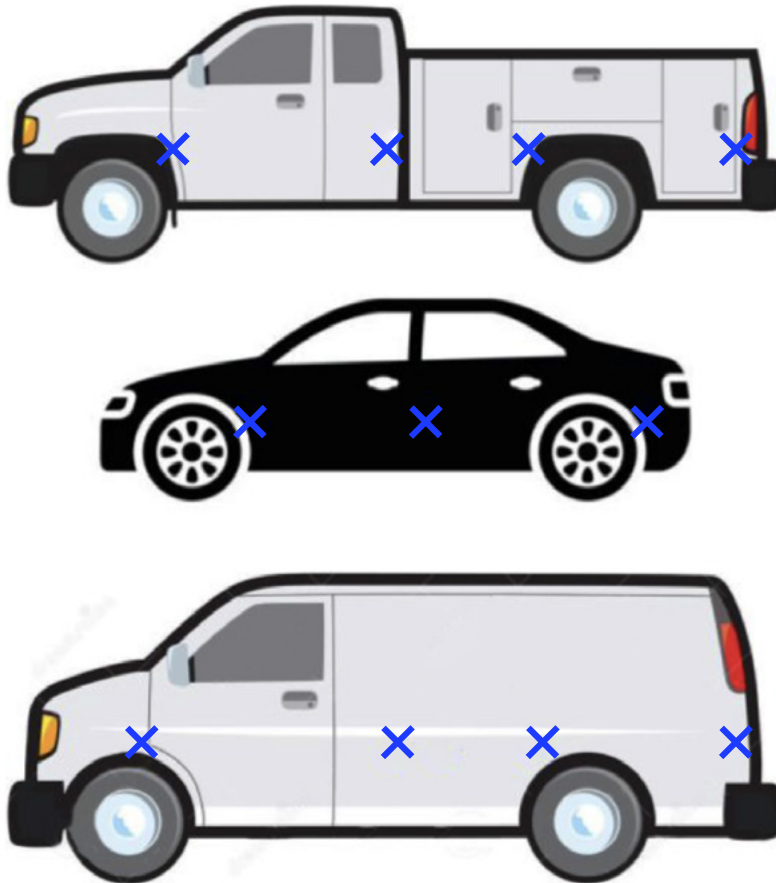

HOLE SAW AND DRILLING

At each of the marked locations, you can begin drilling the mounting hole for the sensor using a 25mm hole saw (15/16th's can be used as a substitute).

Use of cutting oil periodically as you drill each hole is highly recommended, especially on heavy duty bumpers. This will give cleaner edges, faster drilling time, and extend the life of the bit.

Once all of the holes have been cut and cleared of any burrs, you can begin installation of sensors into their mounting holes.

SENSOR AND SLEEVE MOUNTING

Each sensor will have a triangle on the sensor face and the rubber sleeve. Check the alignment on each sensor before following the upcoming steps.

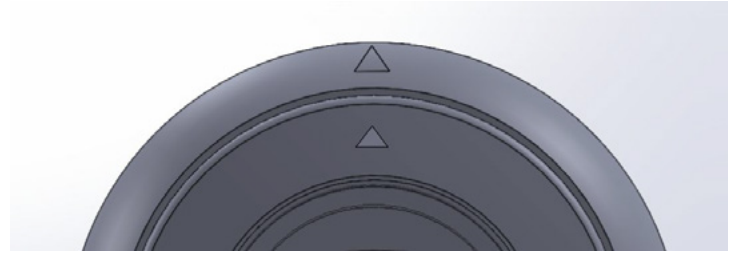

Before inserting, slide the sensor most of the way out of the rubber sleeve. The end of the sensor should be just in front of the ribs that wrap around the rubber sleeve.

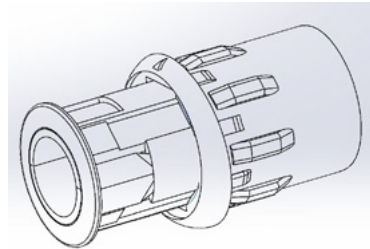

After putting the connector through, slide the sensor and rubber sleeve into the mounting hole as illustrated. Having the sensor positioned far enough back to allow the ribs to compress will make inserting the components much easier. Be sure that the triangle referenced earlier is pointing upward toward the roof of the vehicle.

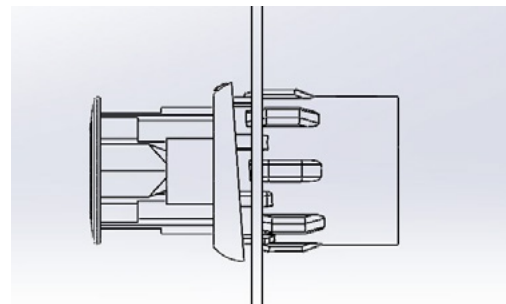
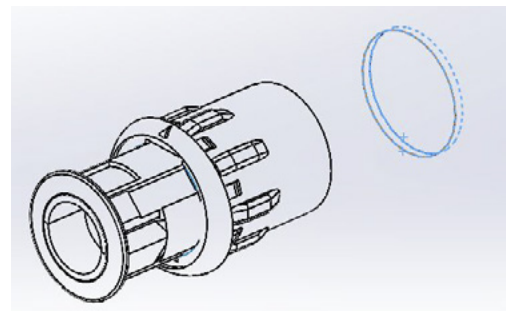

Once the ribs of the rubber sleeve have made it through the mounting hole, you can more easily slide the sensor into the sleeve. The sensor and sleeve will move the rest of the way into the mounting hole and tilt slightly to match the angle of the rubber sleeve.

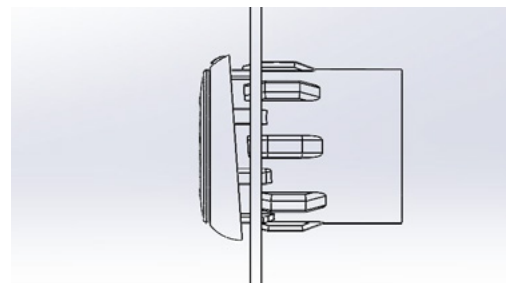

DOOR INSTALLATION INSTRUCTIONS

We do not recommend installation into sliding doors. If the vehicle has sliding doors, it will be necessary to find a different mounting location for the sensor.

Swing door installations should always start with evaluating the interior of the door for clearance, harness route options into the cab, and appropriate places to drill passage holes if there is not already a boot.

If drilling your own passageways into the cab is necessary, follow the basic method shown here. You will need quality grommets to protect the cabling from abrasion and both grommets should be sealed with silicon to protect from water intrusion.

Grommets and silicon are not included with the system.



HARNESS ROUTING (14 Sensor System Variant)

Sensor harnesses are separated by Left/Right and Front/Rear and will be marked on the harness near the connector. Below you will see a simple graphic to show how the sensor harnesses can be routed to the front of the vehicle where the ECU will be installed. Depending on the length of the vehicle, you may need to use one of the supplied extension harnesses to extend the rear sensor harness. You may also need an extension for one of the sides, depending on where the ECU is installed. Make sure to follow factory harness paths, avoid any high temp or high amperage components, and be careful of any places where the harness could become pinched or damaged.

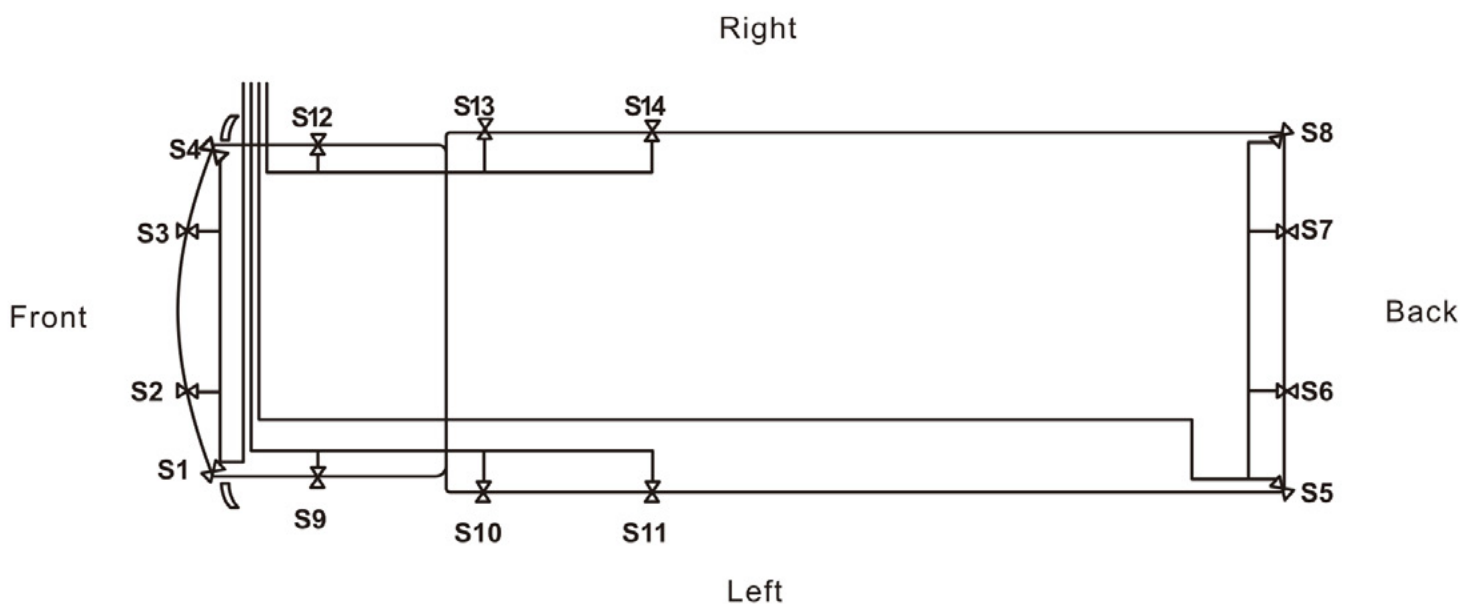

ECU INSTALLATION

First, there has to be a good place for the ECU to be mounted where it can be accessed for service but away from any potential damage while the vehicle is in use.

We recommend looking for a place near the dash first. Very often the driver or passenger kick panel will have all of the characteristics of a good ECU mounting location:

- Room for excess cable to be coiled up and secured
- Access for routing of sensor, display, and GPS cables to the appropriate location
- Located near the necessary vehicle signals
- 12v Accessory and Ground
- Reverse
- Parking Brake (Optional 12v OR Ground trigger to disable the system while the parking brake is engaged)



When making your wire to wire connections, we recommend using solder wherever possible and good splice and tape techniques to ensure a quality connection.

Once a suitable location has been found, you can position the ECU and move on to the following steps. When routing any wires or cables, be sure to follow existing wire routing whenever possible.

- Identify the required vehicle signals using a BCM safe meter. Make your wire connections according to the labels on the ECU power harness.
- Find an appropriate route for the display cable to get to the mounting location on the dash/windshield.
- Find an appropriate route for the GPS module to get to the mounting location on the dash/windshield.
- Route the sensor cables to the ECU locations and connect them according to the labels on the ECU harness.

GPS AND DISPLAY LOCATIONS

GPS can be placed in multiple places that will depend on ECU location and available harness routes. Take note of harness length and possible routes and choose the windshield location that will work best. Mount high on the windshield whenever possible. The LED display can also be mounted in various locations, but this will depend on visibility to the driver. It should be visible to the driver while blocking as little view out of the windshield as possible. The cable will need to run into the dash through a hole if the display is mounted on the dash. Disassemble as much of the dash as needed to confirm a good location before drilling any holes for the display cable.

-  Possible GPS Module Locations
-  Possible Display Locations

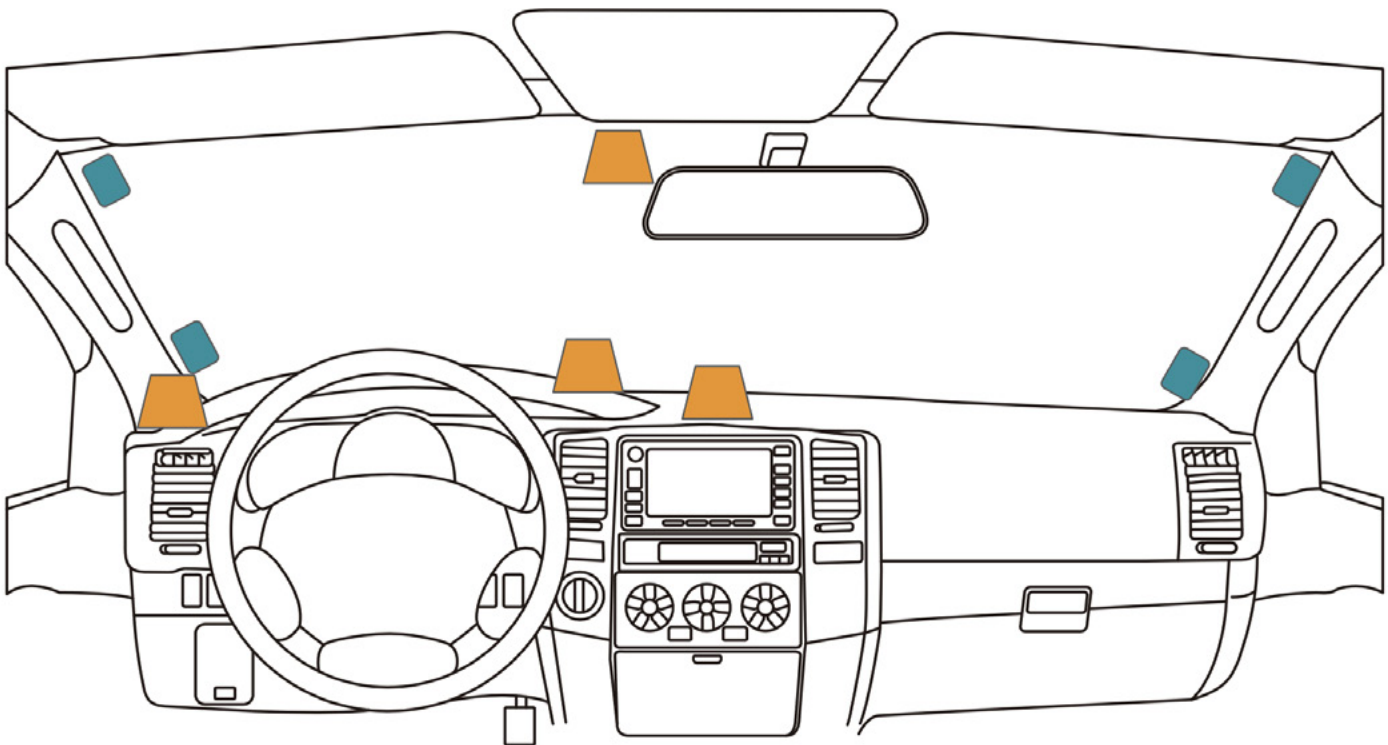

FUNCTIONALITY CHECK

After all of the previous steps have been followed, you can turn the ignition on to confirm that the system is working properly. It is best if the area surrounding the vehicle is completely clear of objects that the sensors might detect.

Once the system powers on, you should see the display light up. In the top right corner of the display you should see a green “Ready” icon and a blue “GPS” icon beginning to flash or turn solid.

Use an object or a helping hand to check that the sensors are both working and connected in the proper order by working clockwise around the vehicle. Use the detection zones on the display to confirm.

To check the rear sensors, you will need to have the vehicle in reverse to activate them. If you made a parking brake connection, you can also check that function during this step, as you will need to apply the parking brake and use a wedge if you are checking this function alone.

Finally, confirm that the GPS is working properly by covering a sensor in a way that causes it to alert and take the vehicle to a speed above 15 mph and the alerts should turn off.

TECHNICAL SPECIFICATION

| ECU | |
|----------------------------|--------------------------|
| Working Voltage | DC 10V-36V |
| Rated voltage/ current | DC24V/1 00mA |
| Power Consumption | ≤3W |
| Response time | 100m5 |
| Working Temperature | -40°C-+80°C |
| Storage Temperature | -45°C-+85°C |
| LED Display | |
| Working Voltage | DC 5V |
| Rated voltage/ current | DC5V/450mA |
| Power Consumption | ≤2.5W |
| Working Temperature | 30°C-+80°C |
| Storage Temperature | -35°C-+85°C |
| Brightness | > 600 lumens |
| Volume | > 85dB |
| Sensor | |
| Working Voltage | DC 11V-16V |
| Rated voltage / current | DC12V/10mA |
| Working Temperature | -40°C-+80°C |
| Storage Temperature | -45°C-+85°C |
| Detection Distance | 0~8FT |
| Working Frequency | 58KHz±1KHz |
| Horizontal detection angle | 110±10 degree |
| Vertical detection angle | 50±10 degree |
| Waterproof IP | IP69 |
| Mounting Location | Front, rear, left, right |
| Hole size | Ø 25mm ± 0.2mm |

ONE YEAR WARRANTY

REAR VIEW SAFETY, INC. WARRANTS THIS PRODUCT AGAINST MATERIAL DEFECTS FOR A PERIOD OF ONE YEAR FROM DATE OF PURCHASE.

WE RESERVE THE RIGHT TO REPAIR OR REPLACE ANY SUCH DEFECTIVE UNIT AT OUR SOLE DISCRETION.

REAR VIEW SAFETY, INC. IS NOT RESPONSIBLE FOR A DEFECT IN THE SYSTEM AS A RESULT OF MISUSE, IMPROPER INSTALLATION, DAMAGE OR MISHANDLING OF THE ELECTRONIC COMPONENTS.

REAR VIEW SAFETY, INC. IS NOT RESPONSIBLE FOR CONSEQUENTIAL DAMAGES OF ANY KIND.

THIS WARRANTY IS VOID IF: DEFECTS IN MATERIALS OR WORKMANSHIP OR DAMAGES RESULT FROM REPAIRS OR ALTERATIONS WHICH HAVE BEEN MADE OR ATTEMPTED BY OTHERS OR THE UNAUTHORIZED USE OF NONCONFORMING PARTS; THE DAMAGE IS DUE TO NORMAL WEAR AND TEAR, THIS DAMAGE IS DUE TO ABUSE, IMPROPER MAINTENANCE, NEGLIGENCE OR ACCIDENT; OR THE DAMAGE IS DUE TO USE OF THE REAR VIEW SAFETY, INC. SYSTEM AFTER PARTIAL FAILURE OR USE WITH IMPROPER ACCESSORIES.

WARRANTY PERFORMANCE

DURING THE ABOVE WARRANTY PERIOD, SHOULD YOUR REAR VIEW SAFETY PRODUCT EXHIBIT A DEFECT IN MATERIAL OR WORKMANSHIP, SUCH DEFECT WILL BE REPAIRED WHEN THE COMPLETE REAR VIEW SAFETY, INC. PRODUCT IS RETURNED, POSTAGE PREPAID AND INSURED, TO REAR VIEW SAFETY, INC. OTHER THAN THE POSTAGE AND INSURANCE REQUIREMENT, NO CHARGE WILL BE MADE FOR REPAIRS COVERED BY THIS WARRANTY.

WARRANTY DISCLAIMERS

NO WARRANTY, ORAL OR WRITTEN, EXPRESSED OR IMPLIED, OTHER THAN THE ABOVE WARRANTY IS MADE WITH REGARD TO THIS REAR VIEW SAFETY, INC.

REAR VIEW SAFETY, INC. DISCLAIMS ANY IMPLIED WARRANTY OR MERCHANTABILITY OR FITNESS FOR A PARTICULAR USE OR PURPOSE AND ALL OTHER WARRANTIES IN NO EVENT SHALL REAR VIEW SAFETY, INC. BE LIABLE FOR ANY INCIDENTAL, SPECIAL, CONSEQUENTIAL, OR PUNITIVE DAMAGES OR FOR ANY COSTS, ATTORNEY FEES, EXPENSES, LOSSES OR DELAYS ALLEGED TO BE AS A CONSEQUENCE OF ANY DAMAGE TO, FAILURE OF, OR DEFECT IN ANY PRODUCT INCLUDING, BUT NOT LIMITED TO, ANY CLAIMS FOR LOSS OF PROFITS.

DISCLAIMER

REAR VIEW SAFETY AND/OR ITS AFFILIATES DOES NOT GUARANTEE OR PROMISE THAT THE USER OF OUR SYSTEMS WILL NOT BE IN/PART OF AN ACCIDENT OR OTHERWISE NOT COLLIDE WITH AN OBJECT AND/OR PERSON. OUR SYSTEMS ARE NOT A SUBSTITUTE FOR CAREFUL AND CAUTIOUS DRIVING OR FOR THE CONSISTENT ADHERENCE TO ALL APPLICABLE TRAFFIC LAWS AND MOTOR VEHICLE SAFETY REGULATIONS. THE REAR VIEW SAFETY PRODUCTS ARE NOT A SUBSTITUTE FOR REAR VIEW MIRRORS OR FOR ANY OTHER MOTOR VEHICLE EQUIPMENT MANDATED BY LAW. OUR CAMERA AND SENSOR SYSTEMS HAVE A LIMITED FIELD OF VISION AND MAY NOT PROVIDE A COMPREHENSIVE VIEW OF THE REAR OR SIDE AREA OF THE VEHICLE. ALWAYS MAKE SURE TO LOOK AROUND YOUR VEHICLE AND USE YOUR MIRRORS TO CONFIRM REARWARD CLEARANCE AND THAT YOUR VEHICLE CAN MANEUVER SAFELY. REAR VIEW SAFETY AND/OR ITS AFFILIATES SHALL HAVE NO RESPONSIBILITY OR LIABILITY FOR DAMAGE AND/OR INJURY RESULTING FROM ACCIDENTS OCCURRING WITH VEHICLES HAVING SOME OF REAR VIEW SAFETY PRODUCTS INSTALLED AND REAR VIEW SAFETY AND/OR ITS AFFILIATES, THE MANUFACTURER, DISTRIBUTOR AND SELLER SHALL NOT BE RELIABLE FOR ANY INJURY, LOSS OR DAMAGE, INCIDENTAL OR CONSEQUENTIAL, ARISING OUT OF THE USE OR INTENDED USE OF THE PRODUCT. IN NO EVENT SHALL REAR VIEW SAFETY AND/OR ITS AFFILIATES HAVE ANY LIABILITY FOR ANY LOSSES (WHETHER DIRECT OR INDIRECT, IN CONTRACT, TORT OR OTHERWISE) INCURRED IN CONNECTION WITH THE SYSTEMS, INCLUDING BUT NOT LIMITED TO DAMAGED PROPERTY, PERSONAL INJURY AND/OR LOSS OF LIFE. NEITHER SHALL REAR VIEW SAFETY AND/OR ITS AFFILIATES HAVE ANY RESPONSIBILITY FOR ANY DECISION, ACTION OR INACTION TAKEN BY ANY PERSON IN RELIANCE ON REAR VIEW SAFETY SYSTEMS, OR FOR ANY DELAYS, INACCURACIES AND/OR ERRORS IN CONNECTION WITH OUR SYSTEMS FUNCTIONS.



A Safe Fleet Brand

Engineered For Vehicle Safety™

If you have questions about this product,
please contact us at:

800.764.1028 sales@rearviewsafety.com
www.rearviewsafety.com

New York

1797 Atlantic Ave
Brooklyn, NY 11233

Indiana

319 Roske Dr.
Elkhart, Indiana 46516

Canada

68 Trafalgar Square
Thornhill, ON, L4J 7M5, Canada